

# Polycarbonate Roofing Installation Instructions

Carefully read all installation instructions before you start. For installation in cyclonic regions, contact your nearest Alsynite New Zealand office for special instructions.

## SAFETY INFORMATION

- Always exercise extreme care when working on a roof. Use walking boards along purlins. **Never walk directly on the sheeting.** Always wear eye protection when using cutting tools.
- For safety precautions Alsynite recommends the use of safety mesh for installations above 3m.
- Alsynite does not recommend the collection of drinking water from any roof without appropriate precautions and filtration. Check with your local water authority for further advice.

## INSTALLATION INFORMATION

- Ensure that your roof pitch is at least 5°, i.e. 88mm rise per lineal metre. This will **ensure adequate water run off.**



- **Allow for ventilation**, particularly at the highest point, to minimise heat build-up and provide air circulation. Good ventilation will also minimise condensation in cold weather.
- Ensure the UV surface protected side faces the sun. This is the **side of the label and the inkjet marking.** When installed as a wall or fence it is recommended that the UV protected side is facing the most sun. The life of the sheet may be shortened and discolouration may occur due to the unprotected side being exposed to UV radiation.
- The sheet can be easily cut with a pair of shears, a fine-toothed handsaw or a circular saw with a cut-off blade suitable for plastic.
- **Temperature changes** will cause expansion and contraction, so make allowances for thermal movement. Resistance to movement can cause buckling.
- To ensure maximum performance of the sheet, and **to avoid buckling**, it is necessary to oversize the holes and centre the fixings.

## PROFILE

### Corrugate

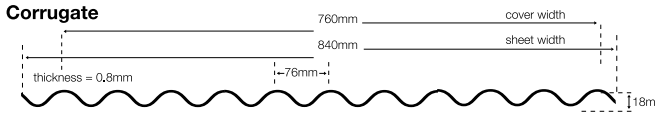

**Available Sizes** (Standard lengths in metres)  
1.8m, 2.1m, 2.4m, 2.7m, 3.0m, 3.6m, 4.2m, 4.8m, 5.4m, 6.0m, 7.2m  
Lengths up to 10 metres can be ordered (conditions apply)

## SIDE LAPS

Corrugate – 1 ½ corrugations

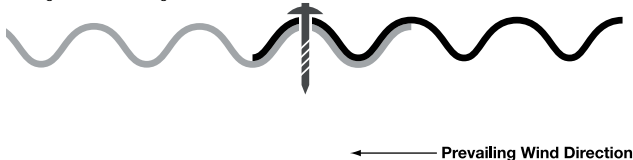

## FIXING SPACINGS

In normal conditions, use the fixing spacings shown in the **table below.** As a guide, you will need approximately 7 fixings per lineal metre. This depends on your purlin spacings and wind conditions. In high wind areas fix Corrugate on every second corrugation on each purlin/batten. It is suggested that barge capping be used. Fix the sheet through the crests for roofing and through the valleys for walls. Use 55mm fixings for Sunline corrugate profile polycarbonate roofing. For **roof laying**, start with the lower sheets first, keeping side laps away from prevailing wind. Allow an overhang of 50mm.

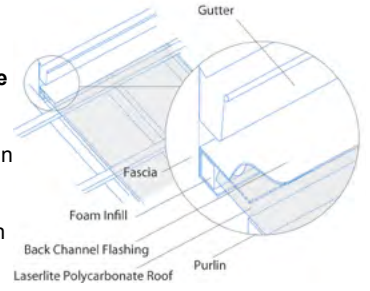

**High Wind Zones:** Use load spreading profile washers. For information on wind zones please visit the Sunline page at [www.alsynite.co.nz](http://www.alsynite.co.nz)

Profile	End Purlins	Mid Purlins
Corrugate	Every 2nd crest	Every 3rd crest

## MAXIMUM PURLIN SPACINGS

For roofing, purlin/batten spacings should be no more than those shown in the table below. For curved structures, the maximum purlin spacing should be 750mm and a minimum radius of 6000mm for Corrugate profile. For walls, noggings spacings should be no more than 1200mm.

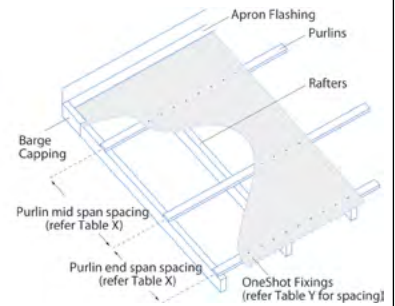

Use **Noise Stop Tape** on all battens, purlins or noggings to minimise the noises associated with expansion and contraction.

Profile	End Span	Mid Span
Corrugate	800mm	1000mm

**CAUTION:** To maximise the life of your Sunline roofing, Alsynite recommends to avoid exposing your polycarbonate sheeting to excess heat from patio heaters. A distance of 1m should be kept between the sheets and the heater, adequate ventilation at all times and temperature to be below 90°C beneath the sheeting. If temperature underneath your sheet rises above 90°C, immediately remove the patio heater from underneath the polycarbonate sheeting.

**IMPORTANT:** These instructions are designed to prevent leaking and alleviate the requirement for sealants. Sealants, especially silicone, are incompatible with polycarbonate. They will damage the sheet, restrict expansion and contraction, and void the warranty. Use the appropriate flashings and infill strips to complete your project and help protect your outdoor entertaining areas from the weather, without the need for sealants.

## HANDLING, STORAGE AND CLEANING

- Store sheets on a flat surface in a well protected and shaded area, out of direct sunlight. Stacked sheets stored in the sun will cause heat build-up and possibly distortion, even if covered. If damage occurs in this situation, warranty is void.
- Prevent moisture getting between stored sheets as this may cause whitening.
- Clean sheets regularly with warm soapy water (mild detergent) and a soft sponge. Take care not to scratch the sheet. Hose down thoroughly.

**CHEMICAL PROPERTIES:** Sunline Polycarbonate Roofing is affected by methylated spirits, benzene, petrol, ketones, acetone, phenols, chlorinated and aromatic hydrocarbons, petroleum-based paints, abrasive cleaners and solvents.

## MAXIMUM RECOMMENDED CURVES

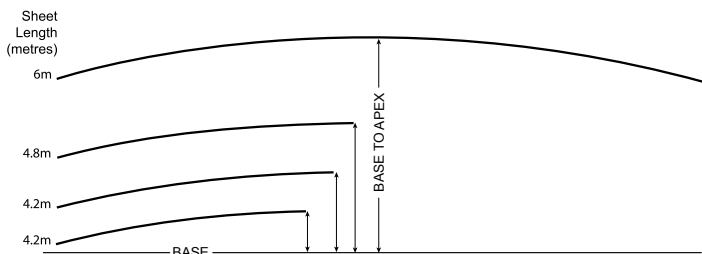

Sheet Length	Depth of Curve
	Corrugate
6.0m	800
4.8m	600
4.2m	400
3.6m	200

## ACCESSORIES

### Polycarbonate Flashings

Available in Clear, 3.0m Lengths.

#### Barge Capping

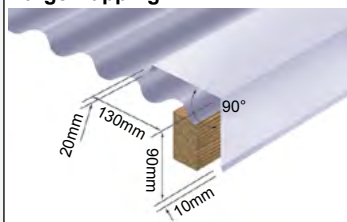

#### Ridge Capping

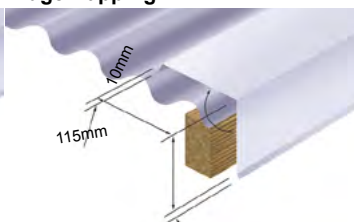

#### Apron Flashing

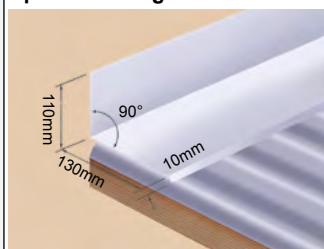

**NOTE: Flashings are available in other dimensions, please contact Alsynite for details 0800 257 964**

## Metal Back Channel Flashings

Prevent leaking at walls and facias

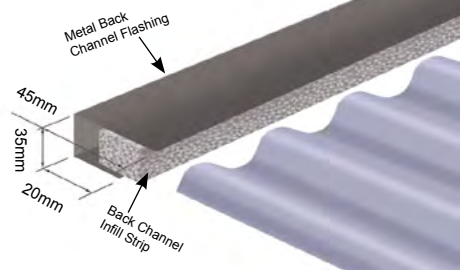

Colours: White and Grey  
Profile: Corrugate  
Length: 3.6m

## Foam Products

Prevent leaking at walls and facias and reduce creaking.

### Eave Infill Strip

Profile: Corrugate  
Length: 975mm  
Colours: Black and White

Prevents rain, dust and wind entering eaves



### Noise Stop Tape

Length: 25m

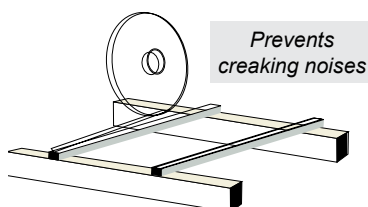

## FASTENERS



All Laserlite fasteners are mechanically plated to comply with AS 3566 Class 4.

Laserlite one-shot pre-drills a 12mm nominal oversized hole to allow for sheet expansion with its unique blade cutter in one step saving you up to 50% installation time. No more pre-drilling required.

### Help your Polycarbonate Roofing perform better

Prevent your Polycarbonate buckling due to changes in temperature by cutting an oversized hole in one action.

### Save 50% Installation time\*

Unique blade cuts an oversized hole in the Polycarbonate, and its strengthened tip drills through the steel or timber batten all in one action. No more pre-drilling required.

### Easy Installation

No more pre-drilling means installation is faster and easier. No extra expense of specialist tools. No extra effort changing tools.

### Professional Finish

Automatically centres the oversized holes to allow the sheet to expand and contract in both directions equally, for the most professional finish. \*50% claim based on number of steps.

### TIMBER

- Corrugate 50mm
- 12 gauge, 11 threads per inch
- Suitable for use with treated timber
- Type 17 (shape of tip)

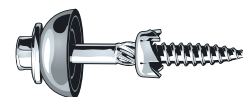

### STEEL

- Corrugate 60mm
- 12 gauge, 11 threads per inch
- Suitable for use with treated timber
- Type 17 (shape of tip)

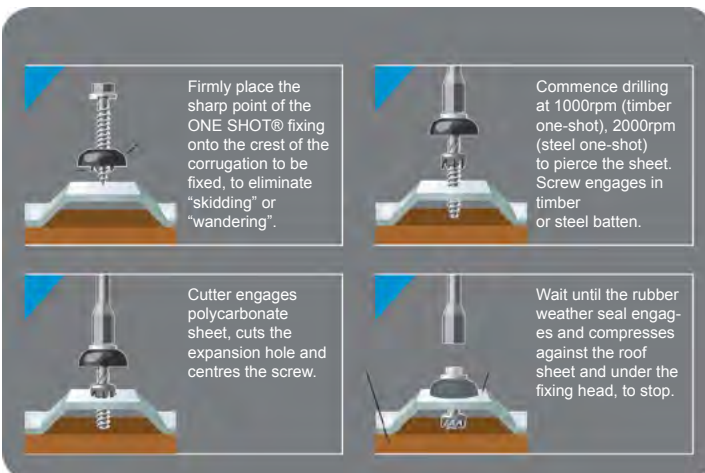

**NB: Alsynite does not recommend One-shot fasteners for high or very high wind zones**

For more information on installing Polycarbonate Roofing, please contact Alsynite 0800 257 964 or visit [www.alsynite.co.nz](http://www.alsynite.co.nz)



# POLYCARBONATE FLASHINGS

Available in Clear, 3.0 metres

